

FJ-17 Flat-Jack

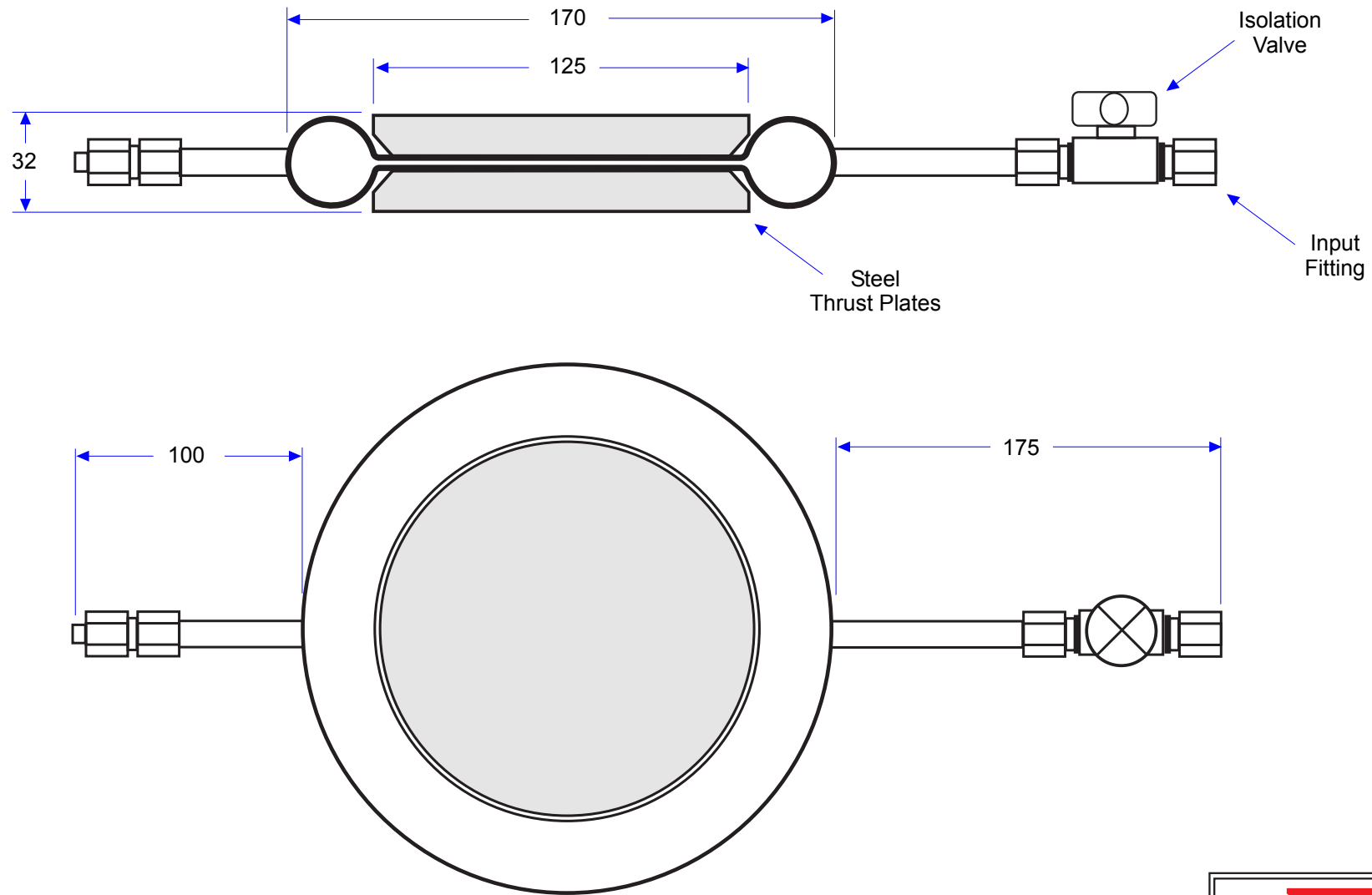

Maximum Capacity: 20 tons
Maximum Stroke: 25mm
Maximum Pressure: 150 bar
Fluid Requirement: 0.8 Lts
Jack Weight: 9.0 Kgs

HYDRA-CAPSULE	
HEAVY DUTY JACKING SYSTEMS	
DESCRIPTION:	FJ-17 Flat-Jack
DRAWING No.	Xara / FJ-17 / 2007-A